

**WhisperRoom** INC.™  
SOUND ISOLATION ENCLOSURES



# Product Catalog

Reducing Sound to a Whisper Since 1990!

# Table of Contents

Features	3
Applications	4
Warranty and Important Information	5
Sound Booth Models	6 - 16
🌀 Two Levels of Isolation	7
🌀 Model Information	8 - 16
🌀 Model Types	16
WhisperRoom Packages	17 - 24
Basic Features	25 - 27
Optional Features	28 - 36
🌀 ADA Package	29
🌀 Acoustic Package	31
🌀 Optional Feature Pricing Chart	36
Assembly Example	37

## Features



26 Sizes



Portable



Modular



Upgradable



Single & Double-Wall



Lifetime Investment



5-Year Warranty



Patented Technology



Worldwide Delivery



Easy Assembly



Expandable



Immediate Shipping

# Applications



Voiceover

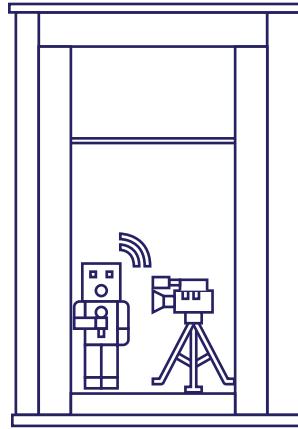

Broadcasting

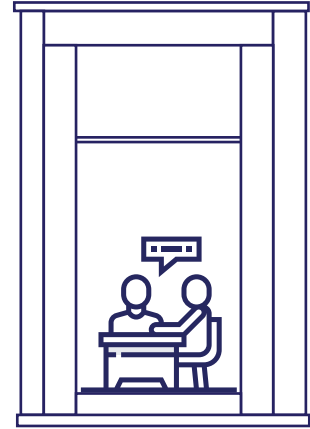

Audiology

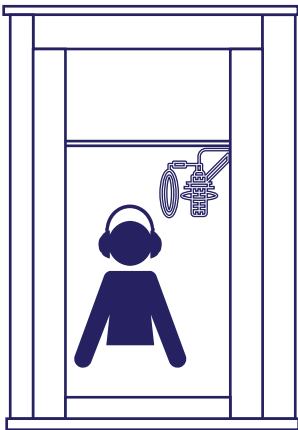

Recording



Practice



Narration / Translation

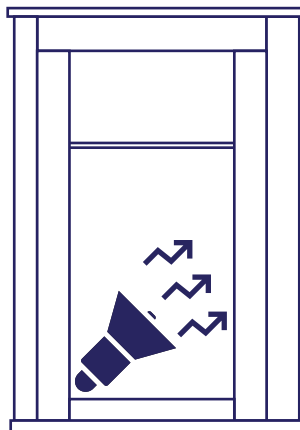

Noise Containment

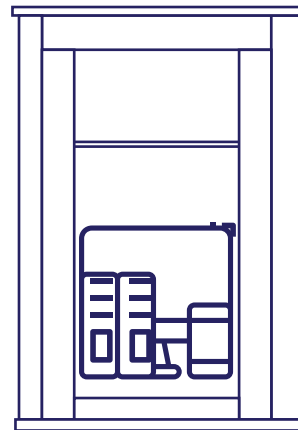

Instruction / E-Learning

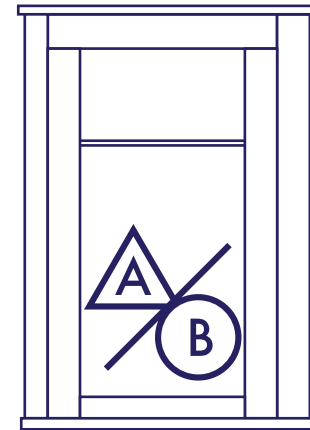

Product Testing

## Warranty and Important Information

### Limited 5-Year Warranty:

WhisperRoom, Inc. will repair or replace, at its factory, any part that may prove to be defective in materials or workmanship, for five years from date of purchase. This warranty does not cover damage resulting from shipping, an accident, mishandling, vandalism, misuse, abuse, alteration, or lack of reasonable care. Any alterations to the WhisperRoom will void this warranty. This warranty is extended to the original owner only and is not transferable.

**NOTE: Manufacturer reserves the right to make design modifications.**

### For Services:

Contact a Product Representative at WhisperRoom, Inc. at 865-558-5364 or 1-800-200-8168. Factory is located at 116 South Sugar hollow Road, Morristown, TN 37813.

### Important Information:

- WhisperRooms are portable/modular sound isolation enclosures designed to significantly reduce the level of sound. WhisperRooms are not soundproof.
- It is the responsibility of the purchaser to ensure the WhisperRoom complies with their specific building codes.
- We at WhisperRoom, Inc. make every attempt to ensure that our customers are 100% confident in their purchase before their order is finalized. However, should an unforeseen situation occur, a return would be considered at the sole discretion of WhisperRoom, Inc.
- Models that are 5' x 5' (MDL 6060) and larger are expandable in the second dimension by the addition of a model-specific Expansion Package, contact a Product Representative for more information.

[Redacted text]

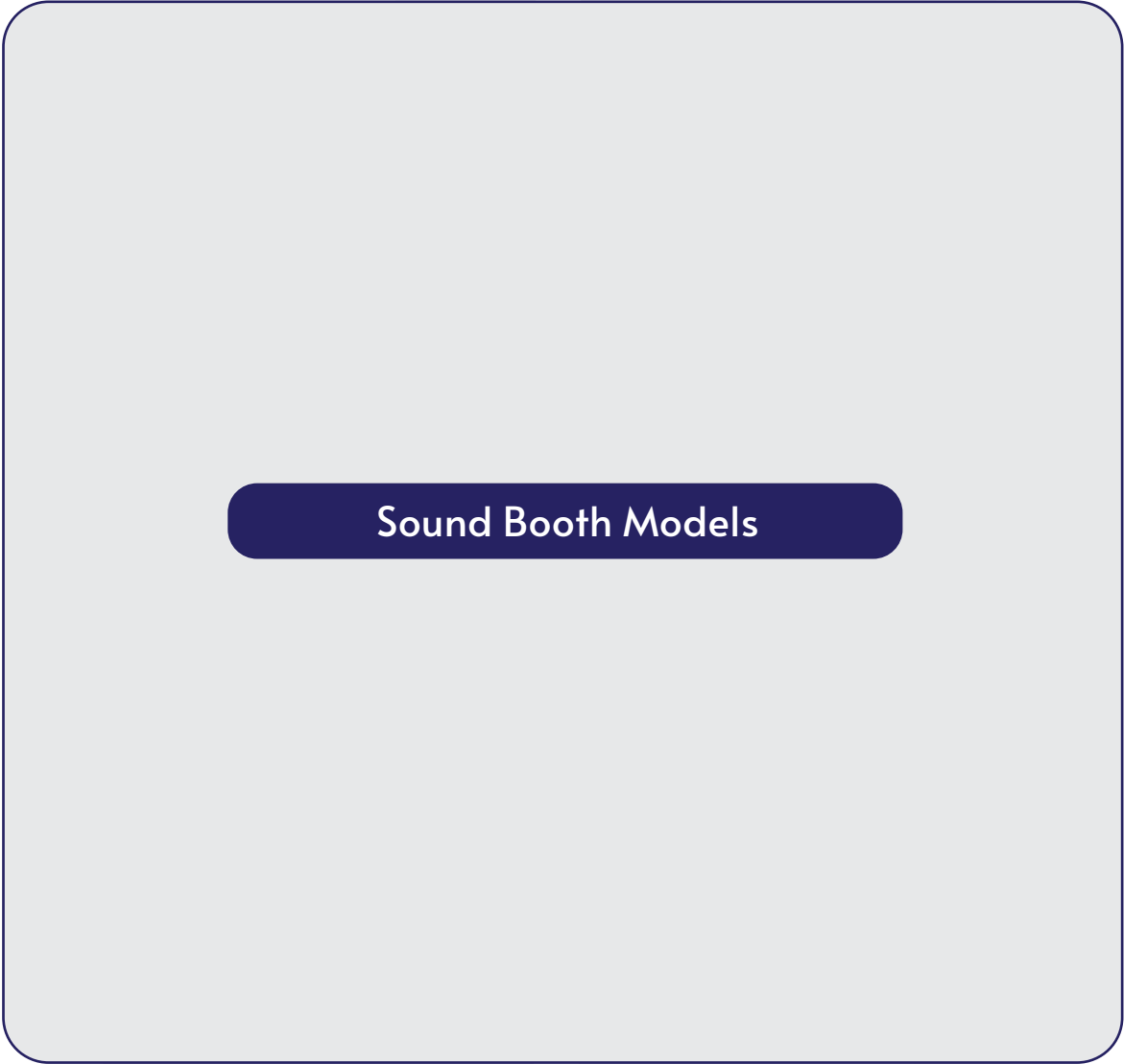

**Sound Booth Models**

[Redacted text]

## Two Levels of Isolation

Models that are 5' x 5' (MDL 6060) and larger are expandable in the second dimension by the addition of a model-specific Expansion Package, contact a Product Representative for more information.

Some applications or locations may require a much greater level of noise reduction than what is offered by a Standard (Single-Wall) WhisperRoom. To accommodate this, Standard units have been preconfigured to allow for the installation of a full set of secondary isolation components creating an Enhanced (Double-Wall) unit. The IEP upgrade is installed on the inside and will decrease the interior space by approximately 4.5" in both dimensions (not including the interior foam).

**NOTE: May be ordered and installed at anytime.**

Standard "S" (Single-Wall)

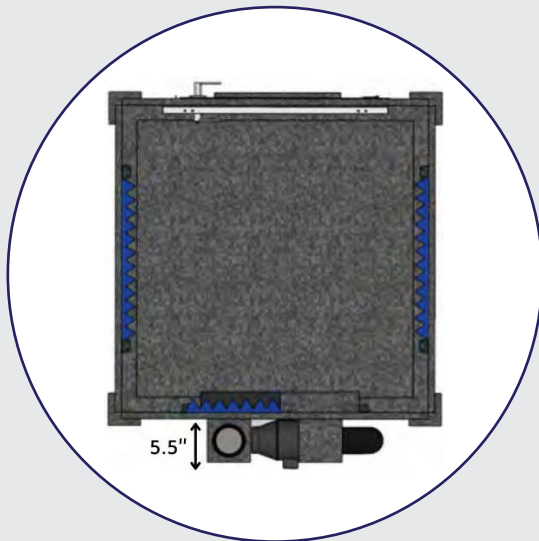

Enhanced "E" (Double-Wall)

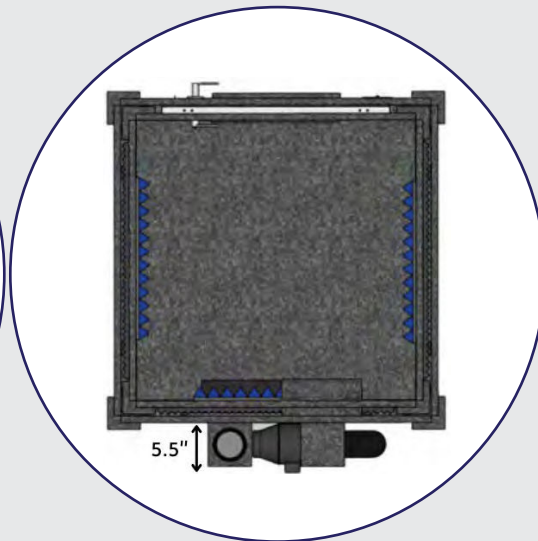

**Note:** Walls configured with a ventilation system will protrude out an extra 5'.5". Some booths will have ventilation configured on multiple walls.

Please visit [whisperroom.com/noise-reduction](https://whisperroom.com/noise-reduction) for more details on isolation.

## MDL 127 LP



Model	Approximate Exterior Size	Approximate Interior Size	Weight (lbs)	USD Price
S	5'5" x 4'6" x 6'11"	12.7 sq. ft.	709	\$6,635
E	5'5" x 4'6" x 7'1"	10.3 sq. ft.	1,228	\$10,920

### Basic Features Included in Price:

- Door Window - 12" x 30"
- 1 Ventilation System (S/E Models)
- 2 Acoustical Foam Sheets - 2' x 4' x 2"
- 1 LED Light - 18"
- 4 Cable Passages

## MDL 4230



Model	Approximate Exterior Size	Approximate Interior Size	Weight (lbs)	USD Price
S	3'8" x 2'8" x 6'11"	3'4" x 2'4" x 6'8"	485	\$5,545
E	3'8" x 2'8" x 7'1"	2'11" x 1'11" x 6'8"	805	\$8,895

### Basic Features Included in Price:

- Door Window - 12" x 30"
- 1 Ventilation System (S/E Models)
- 2 Acoustical Foam Sheets - 2' x 4' x 2"
- 1 LED Light - 18"
- 2 Cable Passages

## MDL 4242



Model	Approximate Exterior Size	Approximate Interior Size	Weight (lbs)	USD Price
S	3'8" x 3'8" x 6'11"	3'4" x 3'4" x 6'8"	555	\$5,595
E	3'8" x 3'8" x 7'1"	2'11" x 2'11" x 6'8"	935	\$8,995

### Basic Features Included in Price:

- Door Window - 12" x 30"
- 1 Ventilation System (S/E Models)
- 2 Acoustical Foam Sheets - 2' x 4' x 2"
- 1 LED Light - 18"
- 2 Cable Passages

**Note:** Model diagrams shown with optional Studio Lights. Walls configured with a ventilation system will protrude out an extra 5.5". Some booths will have ventilation configured on multiple walls.



## MDL 4260



Model	Approximate Exterior Size	Approximate Interior Size	Weight (lbs)	USD Price
S	3'8" x 5'2" x 6'11"	3'4" x 4'10" x 6'8"	685	\$6,695
E	3'8" x 5'2" x 7'1"	2'11" x 4'5" x 6'8"	1,205	\$11,595

### Basic Features Included in Price:

- Door Window - 12" x 30"
- 1 Ventilation System (S/E Models)
- 3 Acoustical Foam Sheets - 2' x 4' x 2"
- 1 LED Light - 18"
- 2 Cable Passages

## MDL 4284



Model	Approximate Exterior Size	Approximate Interior Size	Weight (lbs)	USD Price
S	3'8" x 7'2" x 6'11"	3'4" x 6'10" x 6'8"	875	\$8,850
E	3'8" x 7'2" x 7'1"	2'11" x 6'5" x 6'8"	1,510	\$14,445

### Basic Features Included in Price:

- Door Window - 12" x 30"
- 2 Ventilation Systems (S/E Models)
- 4 Acoustical Foam Sheets - 2' x 4' x 2"
- 1 LED Light - 18"
- 4 Cable Passages

## MDL 4848



Model	Approximate Exterior Size	Approximate Interior Size	Weight (lbs)	USD Price
S	4'2" x 4' 2" x 6'11"	3'10" x 3'10" x 6'8"	680	\$5,995
E	4'2" x 4' 2" x 7'1"	3'5" x 3'5" x 6'8"	1,170	\$9,995

### Basic Features Included in Price:

- Door Window - 16" x 30"
- 1 Ventilation System (S/E Models)
- 3 Acoustical Foam Sheets - 2' x 4' x 2"
- 1 LED Light - 18"
- 2 Cable Passages

Note: Model diagrams shown with optional Studio Lights. Walls configured with a ventilation system will protrude out an extra 5.5". Some booths will have ventilation configured on multiple walls.

## MDL 4872



Model	Approximate Exterior Size	Approximate Interior Size	Weight (lbs)	USD Price
-------	---------------------------	---------------------------	--------------	-----------

S	4'2" x 6'2" x 6'11"	3'10" x 5'10" x 6'8"	880	\$7,395
---	---------------------	----------------------	-----	---------

E	4'2" x 6'2" x 7'1"	3'5" x 5'5" x 6'8"	1,540	\$12,595
---	--------------------	--------------------	-------	----------

### Basic Features Included in Price:

- Door Window - 16" x 30"
- 1 Ventilation System (S/E Models)
- 4 Acoustical Foam Sheets - 2' x 4' x 2"
- 1 LED Light - 18"
- 2 Cable Passages

## MDL 4896



Model	Approximate Exterior Size	Approximate Interior Size	Weight (lbs)	USD Price
-------	---------------------------	---------------------------	--------------	-----------

S	4'2" x 8'2" x 6'11"	3'10" x 7'10" x 6'8"	1,021	\$9,350
---	---------------------	----------------------	-------	---------

E	4'2" x 8'2" x 7'1"	3'5" x 7'5" x 6'8"	1,750	\$15,725
---	--------------------	--------------------	-------	----------

### Basic Features Included in Price:

- Door Window - 16" x 30"
- 2 Ventilation Systems (S/E Models)
- 4 Acoustical Foam Sheets - 2' x 4' x 2"
- 1 LED Light - 18"
- 4 Cable Passages

## MDL 6060



Model	Approximate Exterior Size	Approximate Interior Size	Weight (lbs)	USD Price
-------	---------------------------	---------------------------	--------------	-----------

S	5'2" x 5'2" x 6'11"	4'10" x 4'10" x 6'8"	890	\$9,405
---	---------------------	----------------------	-----	---------

E	5'2" x 5'2" x 7'1"	4'5" x 4'5" x 6'8"	1,555	\$16,200
---	--------------------	--------------------	-------	----------

### Basic Features Included in Price:

- Door Window - 12" x 30"
- 2 Ventilation Systems (S/E Models)
- 4 Acoustical Foam Sheets - 2' x 4' x 2"
- 1 LED Light - 18"
- 4 Cable Passages

Note: Model diagrams shown with optional Studio Lights. Walls configured with a ventilation system will protrude out an extra 5.5". Some booths will have ventilation configured on multiple walls.

## MDL 6084



Model	Approximate Exterior Size	Approximate Interior Size	Weight (lbs)	USD Price
S	5'2" x 7'2" x 6'11"	4'10" x 6'10" x 6'8"	1,050	\$10,445
E	5'2" x 7'2" x 7'1"	4'5" x 6'5" x 6'8"	1,845	\$17,670

### Basic Features Included in Price:

- Door Window - 12" x 30"
- 2 LED Light - 18"
- 2 Ventilation Systems (S/E Models)
- 4 Cable Passages
- 4 Acoustical Foam Sheets - 2' x 4' x 2"

## MDL 7272



Model	Approximate Exterior Size	Approximate Interior Size	Weight (lbs)	USD Price
S	6'2" x 6'2" x 6'11"	5'10" x 5'10" x 6'8"	1,175	\$10,690
E	6'2" x 6'2" x 7'1"	5'5" x 5'5" x 6'8"	2,015	\$18,285

### Basic Features Included in Price:

- Door Window - 16" x 30"
- 1 LED Light - 18"
- 2 Ventilation Systems (S/E Models)
- 4 Cable Passages
- 4 Acoustical Foam Sheets - 2' x 4' x 2"

## MDL 7296



Model	Approximate Exterior Size	Approximate Interior Size	Weight (lbs)	USD Price
S	6'2" x 8'2" x 6'11"	5'10" x 7'10" x 6'8"	1,345	\$11,515
E	6'2" x 8'2" x 7'1"	5'5" x 7'5" x 6'8"	2,330	\$19,800

### Basic Features Included in Price:

- Door Window - 16" x 30"
- 1 LED Light - 18"
- 2 Ventilation Systems (S/E Models)
- 4 Cable Passages
- 5 Acoustical Foam Sheets - 2' x 4' x 2"

Note: Model diagrams shown with optional Studio Lights and Wall Windows. Walls configured with a ventilation system will protrude out an extra 5.5". Some booths will have ventilation configured on multiple walls.

## MDL 8484

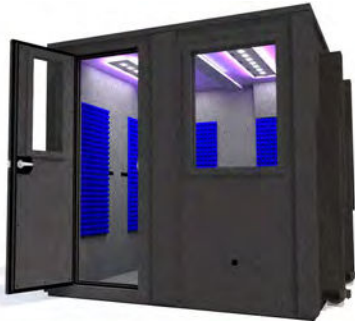

Model	Approximate Exterior Size	Approximate Interior Size	Weight (lbs)	USD Price
S	7'2" x 7'2" x 6'11"	6'10" x 6'10" x 6'8"	1,300	\$12,700
E	7'2" x 7'2" x 7'1"	6'5" x 6'5" x 6'8"	2,240	\$20,710

### Basic Features Included in Price:

- Door Window - 12" x 30"
- 3 Ventilation Systems (S/E Models)
- 5 Acoustical Foam Sheets - 2' x 4' x 2"
- 2 LED Lights - 18"
- 6 Cable Passages

## MDL 84102



Model	Approximate Exterior Size	Approximate Interior Size	Weight (lbs)	USD Price
S	7'2" x 8'8" x 6'11"	6'10" x 8'4" x 6'8"	1,490	\$14,395
E	7'2" x 8'8" x 7'1"	6'5" x 7'11" x 6'8"	2,585	\$23,710

### Basic Features Included in Price:

- Door Window - 12" x 30"
- 3 Ventilation Systems (S/E Models)
- 6 Acoustical Foam Sheets - 2' x 4' x 2"
- 2 LED Lights - 18"
- 6 Cable Passages

## MDL 84126

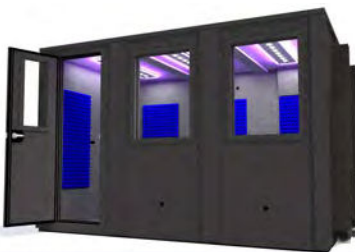

Model	Approximate Exterior Size	Approximate Interior Size	Weight (lbs)	USD Price
S	7'2" x 10'8" x 6'11"	6'10" x 10'4" x 6'8"	1,725	\$16,265
E	7'2" x 10'8" x 7'1"	6'5" x 9'11" x 6'8"	2,965	\$26,270

### Basic Features Included in Price:

- Door Window - 12" x 30"
- 4 Ventilation Systems (S/E Models)
- 6 Acoustical Foam Sheets - 2' x 4' x 2"
- 2 LED Lights - 18"
- 8 Cable Passages

**Note: Model diagrams shown with optional Studio Lights and Wall Windows. Walls configured with a ventilation system will protrude out an extra 5.5". Some booths will have ventilation configured on multiple walls.**

## MDL 9696



Model	Approximate Exterior Size	Approximate Interior Size	Weight (lbs)	USD Price
S	8'2" x 8'2" x 6'11"	7'10" x 7'10" x 6'8"	1,541	\$13,750
E	8'2" x 8'2" x 7'1"	7'5" x 7'5" x 6'8"	2,635	\$23,070

### Basic Features Included in Price:

- Door Window - 16" x 30"
- 3 Ventilation Systems (S/E Models)
- 7 Acoustical Foam Sheets - 2' x 4' x 2"
- 2 LED Lights - 18"
- 6 Cable Passages

## MDL 96120



Model	Approximate Exterior Size	Approximate Interior Size	Weight (lbs)	USD Price
S	8'2" x 10'2" x 6'11"	7'10" x 9'10" x 6'8"	1,798	\$15,910
E	8'2" x 10'2" x 7'1"	7'5" x 9'5" x 6'8"	3,100	\$27,820

### Basic Features Included in Price:

- Door Window - 16" x 30"
- 3 Ventilation Systems (S/E Models)
- 7 Acoustical Foam Sheets - 2' x 4' x 2"
- 2 LED Lights - 18"
- 6 Cable Passages

## MDL 96144



Model	Approximate Exterior Size	Approximate Interior Size	Weight (lbs)	USD Price
S	8'2" x 12'2" x 6'11"	7'10" x 11'10" x 6'8"	2,053	\$17,740
E	8'2" x 12'2" x 7'1"	7'5" x 11'5" x 6'8"	3,514	\$29,475

### Basic Features Included in Price:

- Door Window - 16" x 30"
- 4 Ventilation Systems (S/E Models)
- 8 Acoustical Foam Sheets - 2' x 4' x 2"
- 2 LED Lights - 18"
- 8 Cable Passages

**Note: Model diagrams shown with optional Studio Lights and Wall Windows. Walls configured with a ventilation system will protrude out an extra 5.5". Some booths will have ventilation configured on multiple walls.**

## MDL 96168



Model	Approximate Exterior Size	Approximate Interior Size	Weight (lbs)	USD Price
S	8'2" x 14'2" x 6'11"	7'10" x 13'10" x 6'8"	2,309	\$19,770
E	8' 2" x 14'2" x 7'1"	7'5" x 13'5" x 6'8"	3,969	\$34,015

### Basic Features Included in Price:

- Door Window - 16" x 30"
- 4 Ventilation Systems (S/E Models)
- 9 Acoustical Foam Sheets - 2' x 4' x 2"
- 2 LED Lights - 18"
- 8 Cable Passages

## MDL 96192



Model	Approximate Exterior Size	Approximate Interior Size	Weight (lbs)	USD Price
S	8'2" x 16'2" x 6'11"	7'10" x 15'10" x 6'8"	2,561	\$21,010
E	8'2" x 16'2" x 7'1"	7'5" x 15'5" x 6'8"	4,386	\$36,005

### Basic Features Included in Price:

- Door Window - 16" x 30"
- 4 Ventilation Systems (S/E Models)
- 9 Acoustical Foam Sheets - 2' x 4' x 2"
- 2 LED Lights - 18"
- 8 Cable Passages

## MDL 10284



Model	Approximate Exterior Size	Approximate Interior Size	Weight (lbs)	USD Price
S	8'8" x 7'2" x 6'11"	8'4" x 6'10" x 6'8"	1,475	\$13,865
E	8'8" x 7'2" x 7'1"	7'11" x 6'5" x 6'8"	2,590	\$23,335

### Basic Features Included in Price:

- Door Window - 12" x 30"
- 3 Ventilation Systems (S/E Models)
- 6 Acoustical Foam Sheets - 2' x 4' x 2"
- 2 LED Lights - 18"
- 6 Cable Passages

**Note: Model diagrams shown with optional Studio Lights and Wall Windows. Walls configured with a ventilation system will protrude out an extra 5.5". Some booths will have ventilation configured on multiple walls.**

## MDL 102102



Model	Approximate Exterior Size	Approximate Interior Size	Weight (lbs)	USD Price
S	8'8" x 8'8" x 6'11"	8'4" x 8'4" x 6'8"	1,690	\$15,510
E	8'8" x 8'8" x 7'1"	7'11" x 7'11" x 6'8"	2,985	\$27,375

### Basic Features Included in Price:

- Door Window - 12" x 30"
- 3 Ventilation Systems (S/E Models)
- 7 Acoustical Foam Sheets - 2' x 4' x 2"
- 2 LED Lights - 18"
- 6 Cable Passages

## MDL 102126



Model	Approximate Exterior Size	Approximate Interior Size	Weight (lbs)	USD Price
S	8'8" x 10'8" x 6'11"	8'4" x 10'4" x 6'8"	1,945	\$17,585
E	8'8" x 10'8" x 7'1"	7'11" x 9'11" x 6'8"	3,400	\$30,535

### Basic Features Included in Price:

- Door Window - 12" x 30"
- 4 Ventilation Systems (S/E Models)
- 7 Acoustical Foam Sheets - 2' x 4' x 2"
- 2 LED Lights - 18"
- 8 Cable Passages

## MDL 102144

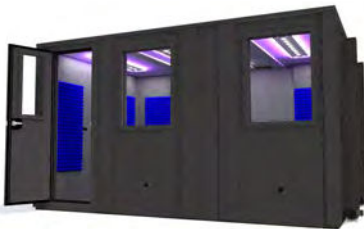



Model	Approximate Exterior Size	Approximate Interior Size	Weight (lbs)	USD Price
S	8'8" x 12'2" x 6'11"	8'4" x 11'10" x 6'8"	2,155	\$19,235
E	8'8" x 12'2" x 7'1"	7'11" x 11'5" x 6'8"	3,795	\$33,520

### Basic Features Included in Price:

- Door Window - 12" x 30"
- 4 Ventilation Systems (S/E Models)
- 8 Acoustical Foam Sheets - 2' x 4' x 2"
- 2 LED Lights - 18"
- 8 Cable Passages

**Note: Model diagrams shown with optional Studio Lights and Wall Windows. Walls configured with a ventilation system will protrude out an extra 5.5". Some booths will have ventilation configured on multiple walls.**

<b>MDL 102168</b>	<b>Model</b>	<b>Approximate Exterior Size</b>	<b>Approximate Interior Size</b>	<b>Weight (lbs)</b>	<b>USD Price</b>
	S	8'8" x 14'2" x 6'11"	8'4" x 13'10" x 6'8"	2,415	\$20,730
	E	8'8" x 14'2" x 7'1"	7'11" x 13'5" x 6'8"	4,210	\$35,595
<b>Basic Features Included in Price:</b>					
<ul style="list-style-type: none"> <li>- Door Window - 12" x 30"</li> <li>- 4 Ventilation Systems (S/E Models)</li> <li>- 9 Acoustical Foam Sheets - 2' x 4' x 2"</li> <li>- 2 LED Lights - 18"</li> <li>- 8 Cable Passages</li> </ul>					

<b>MDL 102186</b>	<b>Model</b>	<b>Approximate Exterior Size</b>	<b>Approximate Interior Size</b>	<b>Weight (lbs)</b>	<b>USD Price</b>
	S	8'8" x 15'8" x 6'11"	8'4" x 15'4" x 6'8"	2,625	\$22,375
	E	8'8" x 15'8" x 7'1"	7'11" x 14'11" x 6'8"	4,605	\$39,640
<b>Basic Features Included in Price:</b>					
<ul style="list-style-type: none"> <li>- Door Window - 12" x 30"</li> <li>- 4 Ventilation Systems (S/E Models)</li> <li>- 9 Acoustical Foam Sheets - 2' x 4' x 2"</li> <li>- 2 LED Lights - 18"</li> <li>- 8 Cable Passages</li> </ul>					

**Note:** Model diagrams shown with optional Wall Windows. Walls configured with a ventilation system will protrude out an extra 5' 5". Some booths will have ventilation configured on multiple walls.

## Model Types

- 🌀 **"S" - Standard (Single-Wall) isolation**                      **"E"- Enhanced (Double-Wall) isolation**
- 🌀 Standard (Single-Wall) models can be upgraded to Enhanced (Double-Wall) models at any time with the addition of a model-specific IEP (Isolation Enhancement Package). Contact a Product Representative for more information.
- 🌀 Diagrams shown are Enhanced (Double-Wall) models. Some diagrams are shown with optional Wall Windows and Caster Plate. Note: Caster Plate adds 5' to exterior height.
- 🌀 Weights listed are assembled weights. Adding optional features will increase the weight.
- 🌀 Prices do not include shipping cost. Contact a Product Representative for a shipping quote.
- 🌀 Expansion Packages are available for models 5'x 5' and larger. Contact a Product representative for more information.



[Redacted text]



**WhisperRoom Packages**

[Redacted text]

## Voice Over Basic Package

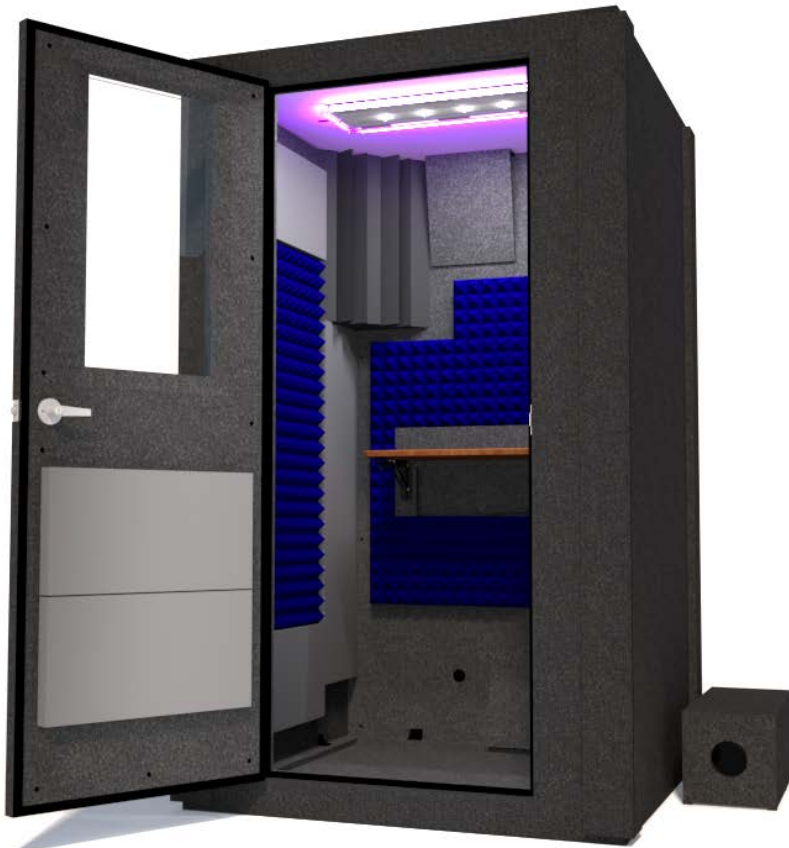

This is an excellent choice if you are looking to avoid minor background noise while recording audiobooks, e-learning transcripts, or audio for commercials and advertisements.

Whatever your next project might be, this booth has several added features to help you produce the highest quality of audio for your clients.

The Voice Over Basic package includes our MDL 4848 S which is a single-wall booth with exterior dimensions of 4' 2" x 4' 2" x 6' 11". This booth comes standard with ventilation, a door window, Auralex studio foam (3 sheets), and cable passages for your wiring needs.

Additionally, several of our most popular optional features for voice-over artists come with the package. The Voice Over Basic includes a Ventilation Silencing System, the Exterior Fan Silencer, our multi-colored LED Studio Light, a foldable Office Desk, the Acoustic Package and Auralex LENRD Bass Traps (2).

MDL 4848 S	\$5,995
Ventilation Silencing System	\$645
Exterior Fan Silencer	\$250
Office Desk	\$299
Studio Light	\$325
Auralex® LENRD Bass Traps (2)	\$120
Acoustic Package	\$372

**= \$8,006**

+ 5% Package Discount

Total:

**\$7,605.70**

**\*Shipping not included in price**

## Voice Over Deluxe Package

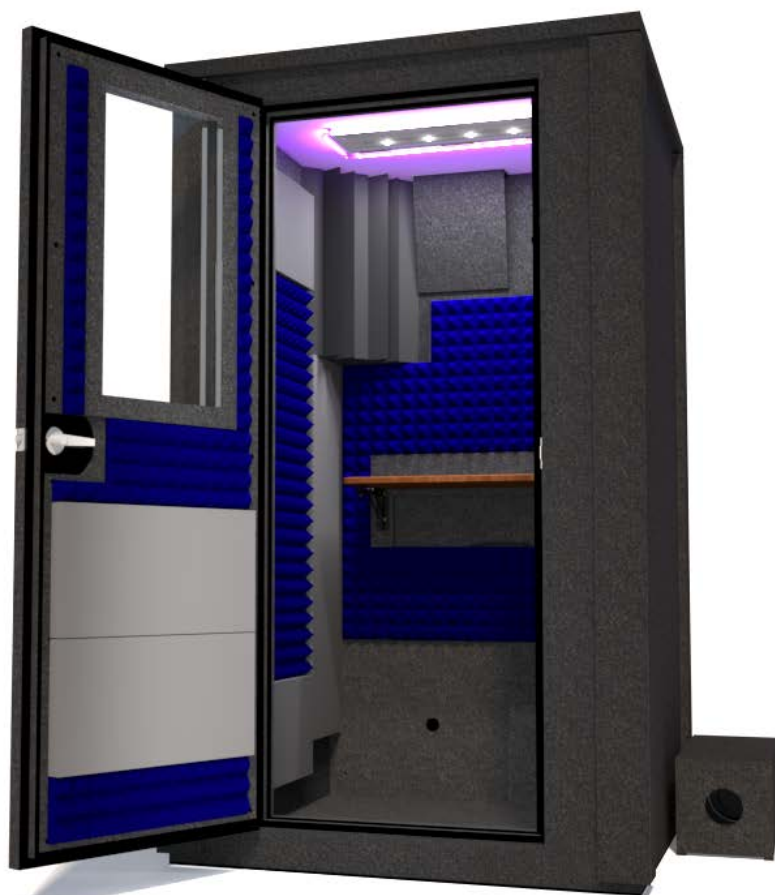

Need greater sound isolation in your voice over studio? We have just what you're looking for.

The "deluxe" package features a double-wall design for maximum isolation and includes all the bells and whistles to help you produce the highest quality voice-over audio for your clients.

The Voice Over Deluxe package consists of our MDL 4848 E which is a double-wall booth with exterior dimensions of 4' 2" x 4' 2" x 7' 1". The booth comes equipped with ventilation, a door window, Auralex studio foam (3 sheets), and cable passages for your wiring needs.

Additionally, several of our most popular optional features for voice-over artists come with the package. The Voice Over Deluxe includes a Ventilation Silencing System, the Exterior Fan Silencer, our multi-colored LED Studio Light, a foldable Office Desk, the Acoustic Package, and Auralex LENRD Bass Traps (2).

MDL 4848 E	\$9,995
Ventilation Silencing System	\$645
Exterior Fan Silencer	\$250
Office Desk	\$299
Studio Light	\$325
Auralex® LENRD Bass Traps (2)	\$120
Acoustic Package	\$372

---

= \$12,006

+ 5% Package Discount

Total: **\$11,405.70**

\*Shipping not included in price

# Audiology Basic Package

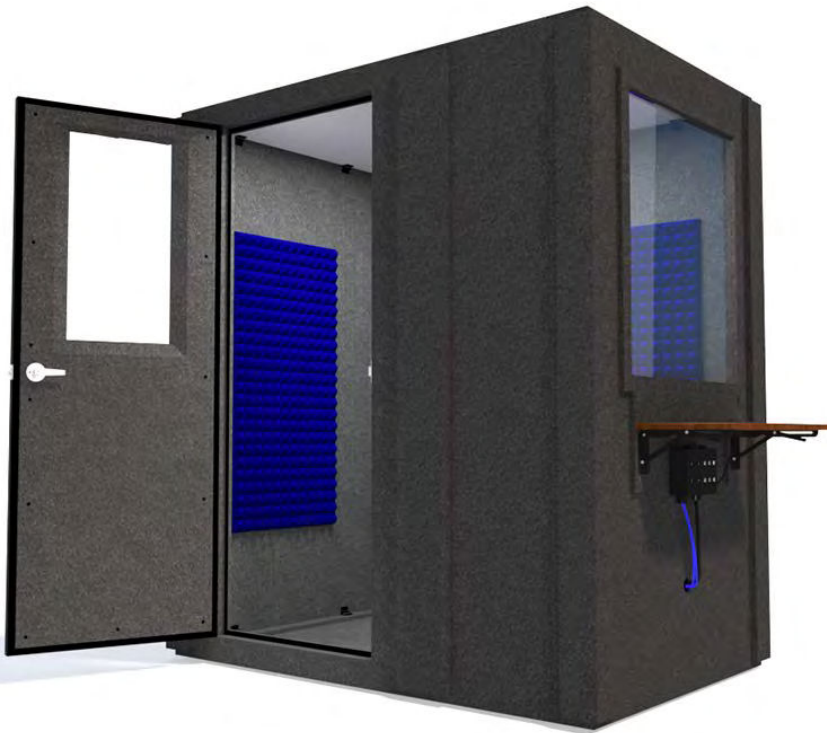

This attractive Audiology Basic package is the ideal controlled-screening environment for you and your patients.

This booth meets all ANSI and OSHA standards for hearing conservation programs and other required hearing tests. Plus, it's simple to build, easy to relocate, and will fit nice inside of your office.

This package includes our MDL 4872 S which is a single-wall booth with exterior dimensions of 4' 2" x 6' 2" x 6' 11". This booth comes standard with ventilation, a door window, and cable passages for your wiring needs.

Additionally, a 32" x 36" window will provide a clear line of sight for easy communication with your patients, and our pre-wired Multi Jack Panel (MJP) will deliver effortless medical equipment integration, and the Office Desk gives space for testing equipment.

The ventilation system includes our Ventilation Silencing System (VSS) to mute airflow noise inside the unit and the Exterior Fan Silencer (EFS) to reduce fan noise outside of the booth.

If your medical practice is looking for a new room to perform diagnostic audiology testing, look no further.

MDL 4872 S	\$7,395	
Multi Jack Panel	\$795	
Standard Window (32" x 36")	\$720	+ 5% Package Discount
Office Desk	\$299	
Exterior Fan Silencer	\$250	
Ventilation Silencing System	\$645	

**Total: \$9,598.80**

**\*Shipping not included in price**

---

= \$10,104

# Audiology Deluxe Package

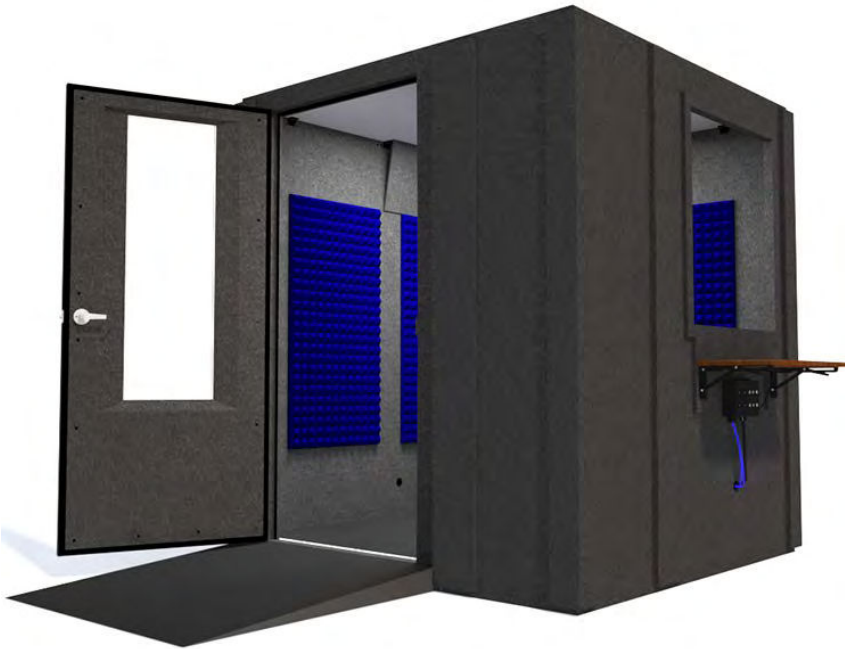

The Audiology Deluxe package is a spacious audiology suite that's designed to give access and accommodation to everyone who needs a hearing evaluation.

This booth meets both ANSI and OSHA standards, and it is fully compliant with the Americans with Disabilities Act (ADA).

This package includes our MDL 7272 S which is a single-wall booth with exterior dimensions of 6' 2" x 6' 2" x 6' 11". This booth comes standard with ventilation, a door window, and cable passages for your wiring needs.

Additionally, a 32" x 36" window will provide a clear line of sight for easy communication with your patients, our pre-wired Multi Jack Panel (MJP) will deliver effortless medical equipment integration, the Office Desk gives space for testing equipment, and the ADA package (includes an elevated floor, wide access door, and ramp for wheelchair access) will allow easy access for physically-challenged patients.

The ventilation system includes our Ventilation Silencing System (VSS) to mute airflow noise inside the unit and the Exterior Fan Silencer (EFS) to reduce fan noise outside of the booth.

MDL 7272 S	\$10,690
ADA Package	\$2,240
Multi Jack Panel	\$795
Standard Window (32" x 36")	\$720
Office Desk	\$299
Exterior Fan Silencer	\$500
Ventilation Silencing System	\$1,290

+5% Package Discount

Total:

**\$15,707.30**

\*Shipping not included in price

= \$16,534

## Office Booth



The WhisperRoom™ Office Booth is convenient for important phone calls and video meetings.

Whether you need to get on the phone, join a video chat with your colleagues, or spend time focusing without distractions, owning a WhisperRoom™ will give you a quiet solution that secures your private conversations.

Substantially improve the environment of your noisy office or home workplace with this office phone booth.

This package includes our MDL 4242 S which is a single-wall booth with exterior dimensions of 3' 8" x 3' 8" x 7' 3 1/2". Additionally, this booth comes with a Ventilation System, a Door Window, Cable Passages for your wiring needs, an Office Desk, a Studio Light, a 26" x 48" Wall Window, and a Caster Plate for mobility.

MDL 4242 S	\$5,595
Standard Window (26" x 48")	\$775
Caster Plate	\$580
Office Desk	\$299
Studio Light	\$325

---

= \$7,574

+ 5% Package Discount

Total: **\$7,195.30**

\*Shipping not included in price

## Work From Home Booth



The Work From Home Booth is a practical space to take calls, manage meetings, or work privately in a quiet space.

For those of us that are forced to work from home, noisy interruptions can cause a frustrating workday. Decrease those distractions and conduct video conference calls without disruptions or spectators watching you through the window.

The Work From Home Booth package includes our MDL 4872 S which is a single-wall booth with exterior dimensions of 4' 2" x 6' 2" x 6' 11". This booth comes with a Ventilation System, a Door Window, Cable Passages for your wiring needs, our foldable Office Desk, Auralex Studiofoam (6 sheets), and a multi-colored Studio Light.

MDL 4872 S	\$7,395
Office Desk	\$299
Studio Light	\$325

+ 5% Package Discount

Total: **\$7,618.05**

---

= \$8,019

---

\*Shipping not included in price

## Drum Booth Package

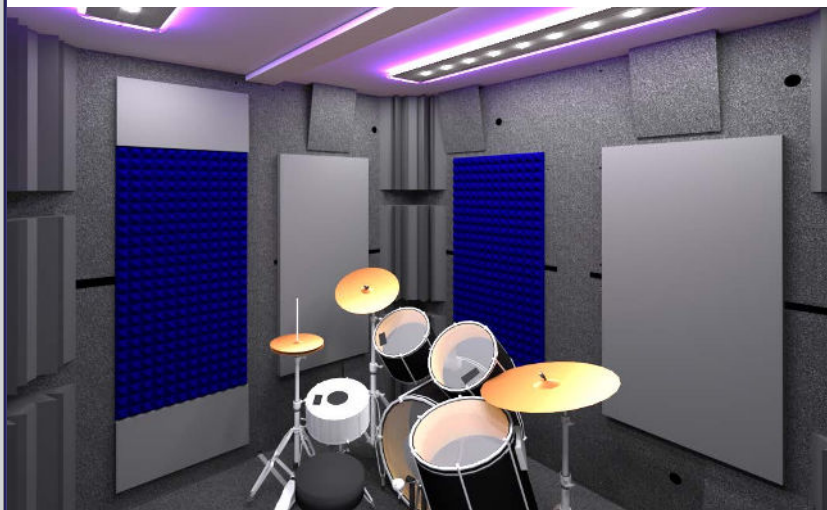
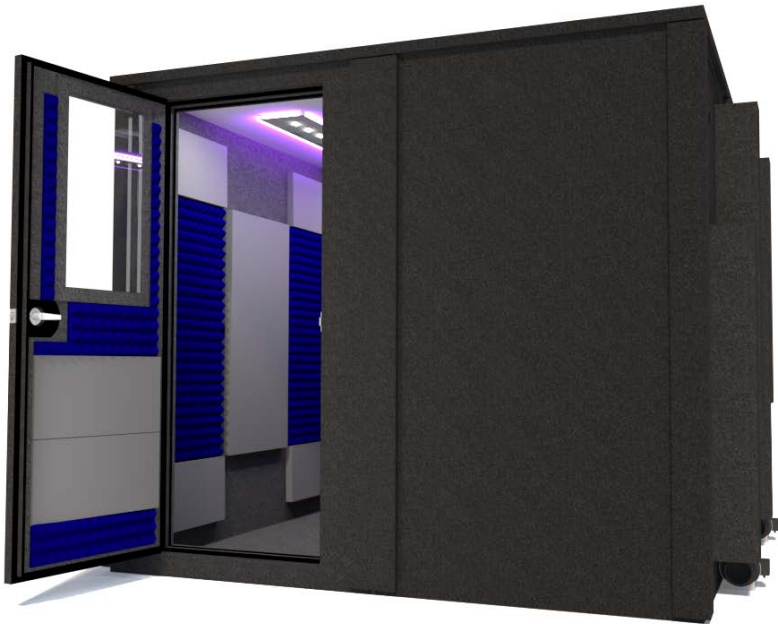

The Drum Booth Package is a space for drummers to practice and record at full volume without disturbing others.

This double-wall drum isolation booth is sturdier than any other drum cage on the market and will drastically reduce the noise of your entire drum kit. Whether you need to rehearse for hours at a time, record drums late at night, or keep noise to a minimum, this portable drum enclosure gives you the power to get loud.

The Drum Booth Package includes our MDL 9696 E which is a double-wall booth with exterior dimensions of 8' 2" x 8' 2" x 7' 1" tall. This booth comes with 3 Ventilation Systems, a Door Window, and 6 Cable Passages for your wiring needs. Additionally, 8 LENRD Bass Traps, 7 sheets of Auralex 2-inch Studiofoam, the Acoustic Package, and two 52" Studio Lights are included.

MDL 9696 E	\$23,070
LENRD® Bass Traps (8)	\$480
Acoustic Package	\$668
52" Studio Lights (2)	\$830

= \$25,048

+ 5% Package Discount

Total:

**\$23,795.60**

\*Shipping not included in price



[Blurred text at the top of the page]

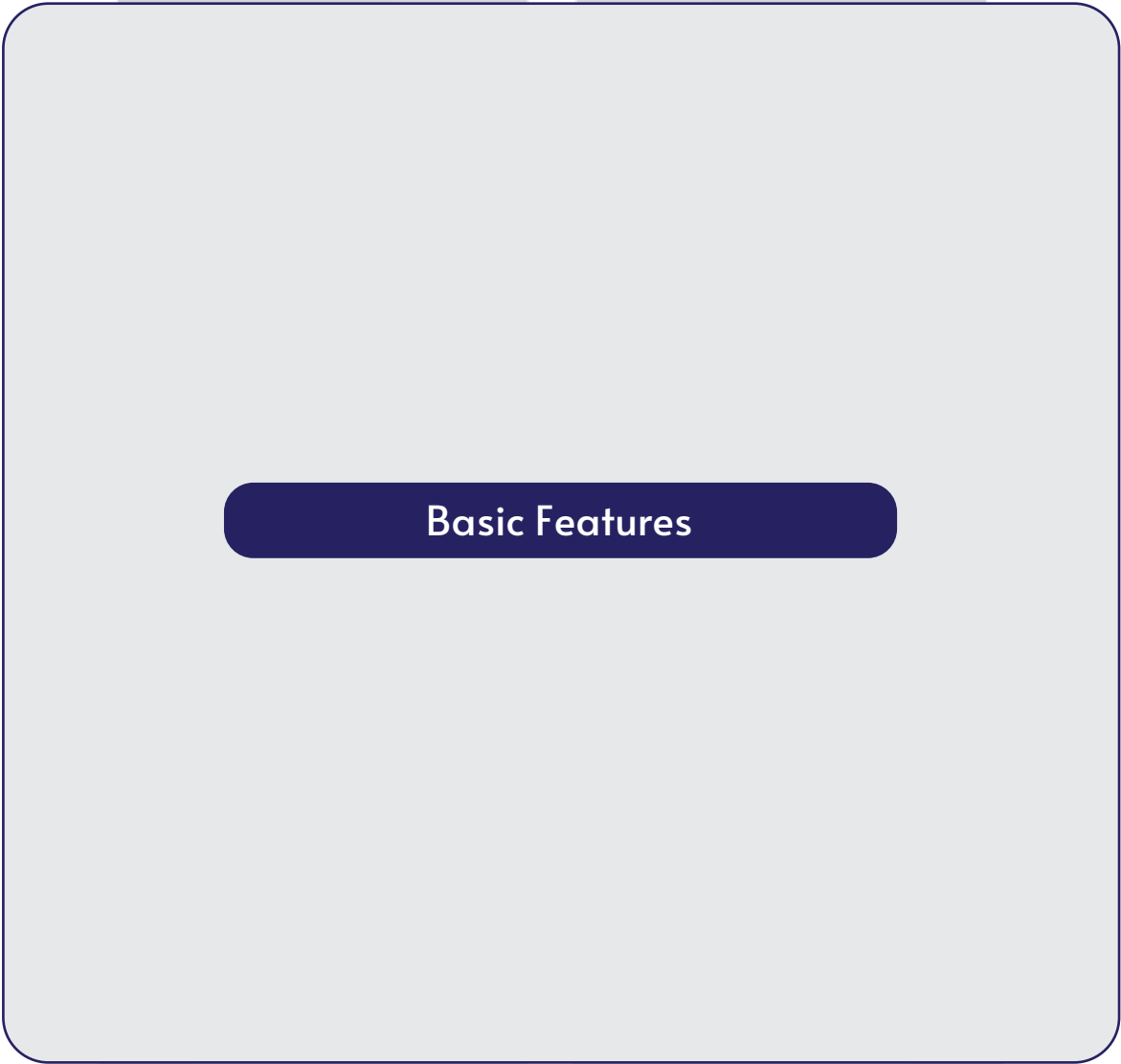

**Basic Features**

[Blurred text at the bottom of the page]

## Basic Features



**Door Window**

A door window is provided with each WhisperRoom. Each glass unit consists of multiple layers of 1/4" laminated safety glass separated by an air buffer(s). Safety glass is used because of its superior noise reduction capabilities and safety features. If broken, it will not shatter.

The door window does not reduce the noise reduction capability of a WhisperRoom. It does, however, increase the amount of interior reflective surface area.

**Note: Doors are available without a window.**

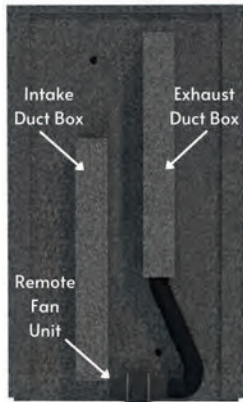

**Ventilation System**

Effective air circulation is accomplished by acoustically engineered, detachable ventilation systems which circulate air at a rate of 80 CFM (cubic feet per minute). The number of systems required depends on the size of the WhisperRoom unit. Roof-mount ventilation systems are also available for most models.

**Note: We also offer our rooms without ventilation.**

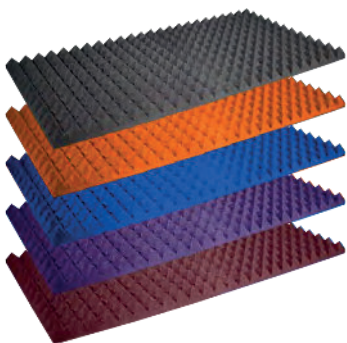

**Acoustical Foam**

Each model comes with enough Auralex® acoustical foam to cover about 1/3 of the interior. Each sheet is 2' x 4' and 2" thick and attaches to the interior with Velcro®. This allows the user to customize the interior acoustics to suit their needs.

The foam can easily be added to or removed from, the WhisperRoom for applications where a more dead or live environment is desired.

**Note: See page 34 for pricing.**

## Basic Features



**Light - 18" LED**

Lights shipped with WhisperRooms are intended to provide customers with basic startup lighting. It is understood that most customers will ultimately purchase and install lighting fixtures more suitable to their individual needs and desires. One or two lights are provided depending on the enclosure's size.

WhisperRoom reserves the right to substitute for a comparable product.

**Note: Lights are UL approved. Additional lights may be purchased for \$20.00 each.**



**Cable Passages**

Access for communications such as microphones, headphones, speakers, and electrical cables is accomplished by way of slotted rubber cable passage plugs. Simply remove the plug, insert the cable(s) into the slots and re-insert the plug into the wall. Two or more cable passage plugs are provided with each WhisperRoom and each will accommodate multiple cables.

The number of cable passages depends on the size of the unit. Also, an additional cable passage is located at the base of each optional window component.



**Wireless Switch**

A wireless remote switch is provided with each WhisperRoom to control the 18" LED lights. This allows the user to turn the lights on/off from inside the WhisperRoom. The wireless switch is not included with WhisperRoom purchases that include a Studio Light.

WhisperRoom, Inc. reserves the right to substitute for a comparable product.

**Note: Additional Wireless Switches may be purchased for \$30.00 each. Switches do not ship with non-ventilation models.**

[Redacted text]

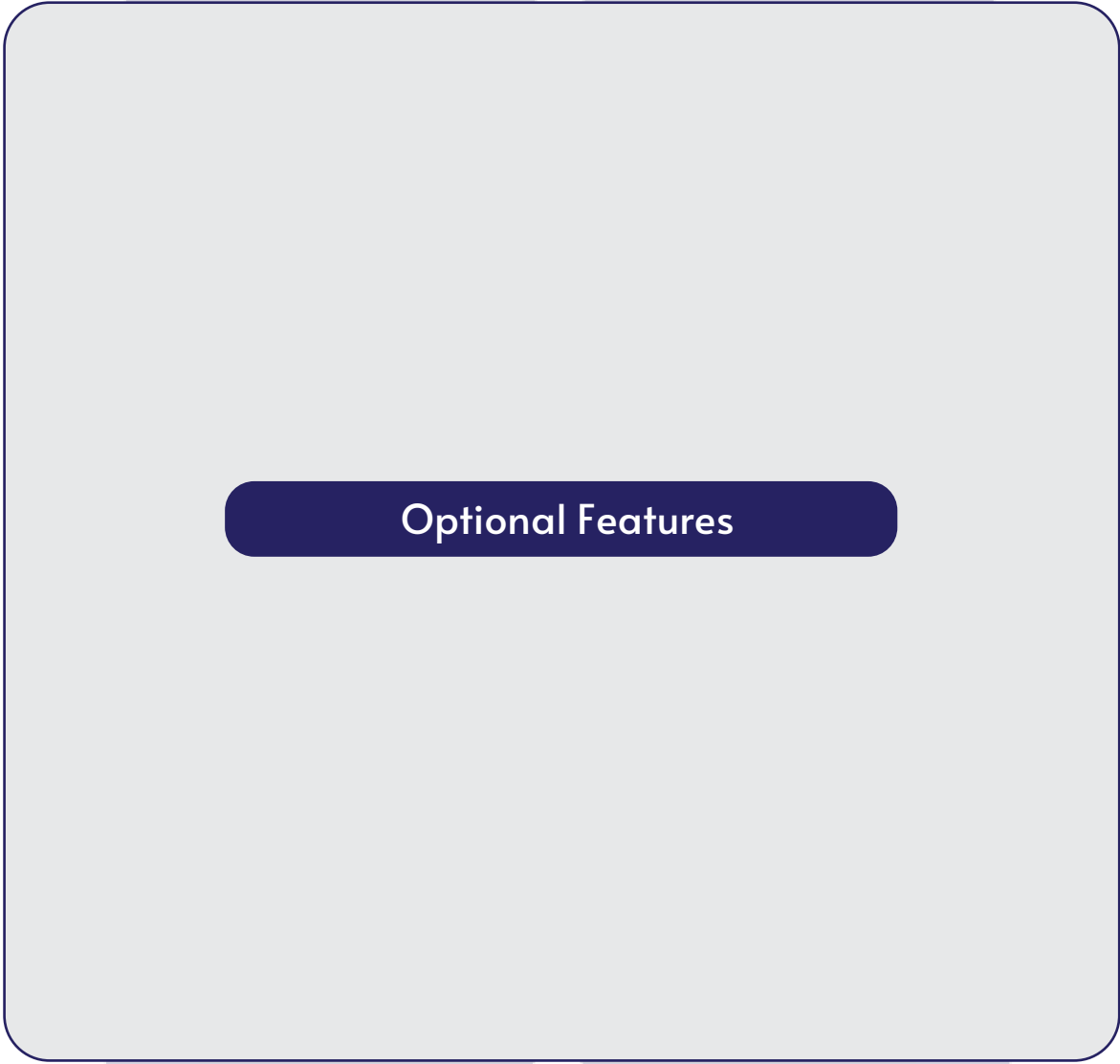

**Optional Features**

[Redacted text]

## ADA Package

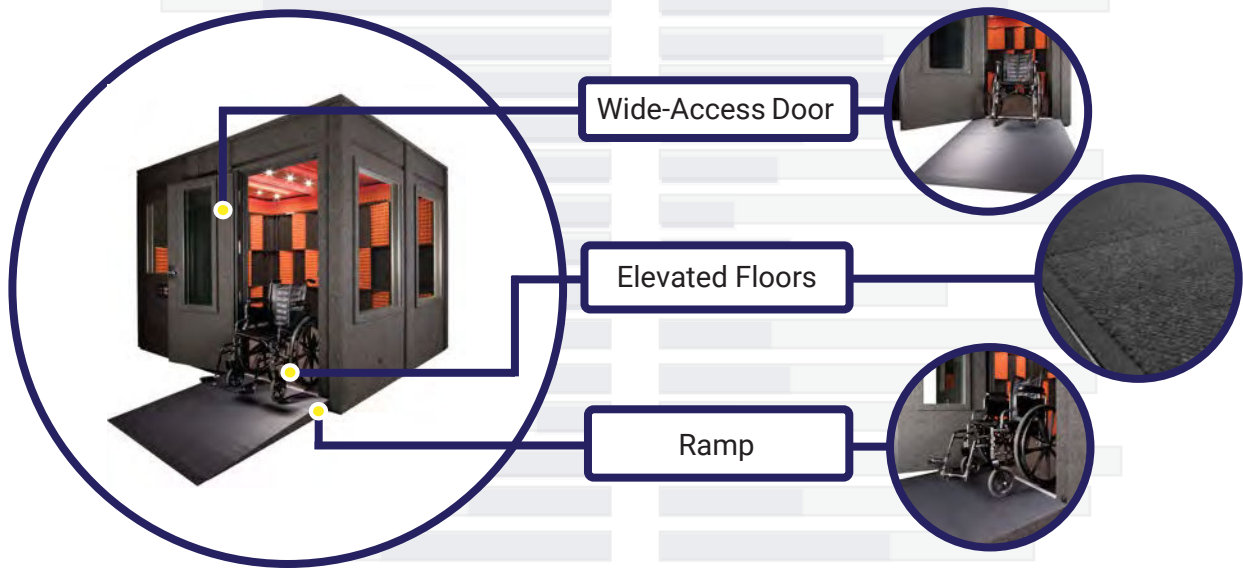

The ADA Package includes the following components to allow easy accessibility for people with disabilities:

- 👁️ A 32" wide door opening
- 👁️ A 1:12 ratio ramp
- 👁️ A door handle operable with a closed fist
- 👁️ A raised floor
- 👁️ A "no threshold" door design

Each of the seven available sizes has at least a five-foot interior space for wheelchair maneuverability. All ADA Package sizes are available in both our Standard (Single-Wall) and Enhanced (Double-Wall) versions.

The 2010 Americans with Disabilities Act standards which apply to state & local governments, public accommodations, and commercial facilities state that "the 2010 Standards apply to fixed or built-in elements of buildings, structures, site improvements, pedestrian routes, or vehicular ways located on site". Because the WhisperRoom is neither built-in, nor a fixed element/structure, there is no technical requirement for the WhisperRoom to comply with the 2010 ADA standards.

**Note: Must be specified at initial order.**

Standard Pricing		Enhanced Pricing	
ADA 7272 S	\$2,240	ADA 7272 E	\$2,305
ADA 7296 S	\$2,730	ADA 7296 E	\$2,775
ADA 9696 S	\$3,370	ADA 9696 E	\$3,390
ADA 96120 S	\$4,010	ADA 96120 E	\$4,005
ADA 96144 S	\$4,650	ADA 96144 E	\$4,620
ADA 96168 S	\$5,290	ADA 96168 E	\$5,235
ADA 96192 S	\$5,925	ADA 96192 E	\$5,850

## WA - Wide-Access Door



### Standard

\$ 517

### Enhanced

\$ 957

### Wide Access Ramp

\$ 445

Any WhisperRoom with a 5' wall or larger can be configured with a Wide-Access Door upgrade. This upgrade is perfect for applications which require the passage of large items into and out of the WhisperRoom. Wide-Access Doors include a 16" x 48" door window.

**Note: Must be specified at initial order.**

## Office Desk



Available in two sizes. Choose between the 30" and 42" width options to maximize your workspace. Both sizes come with two USB outlets and two 120-volt outlets conveniently attached to the desk so you can plug right in. Crafted from red oak, each desk comes preattached to a backing panel with adjustable hinges, allowing you to fold it down and free up additional space in your booth when needed. The desk can be installed inside or outside your WhisperRoom.

**Office Desk Small:** \$ 299     **Office Desk Large:** \$ 399

## SL - Studio Light Package

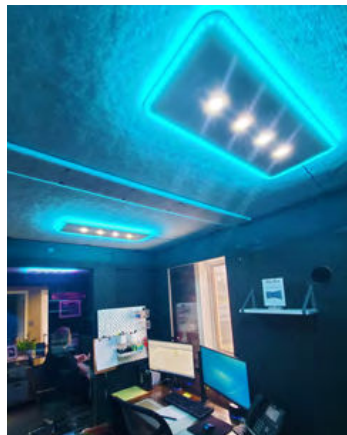
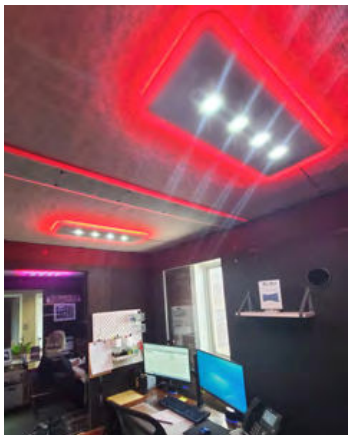

As with all WhisperRoom features, the optional Studio Light series provides maximum flexibility. Dual light systems, LED puck-lights for general lighting, and multicolored LED lights for mood/ambiance are all incorporated into this unique design. Both create no noise or heat, and can easily be adjusted for desired brightness.

In addition, the multicolored lights can be single color or alternating colors, as well as a variety of other functions using a remote control, which is included. The Studio Light in conjunction with the numerous interior acoustical foam colors provide many possibilities. The size and quantity of Studio Lights included in each package is determined by the size of the WhisperRoom.

## AP - Acoustic Package

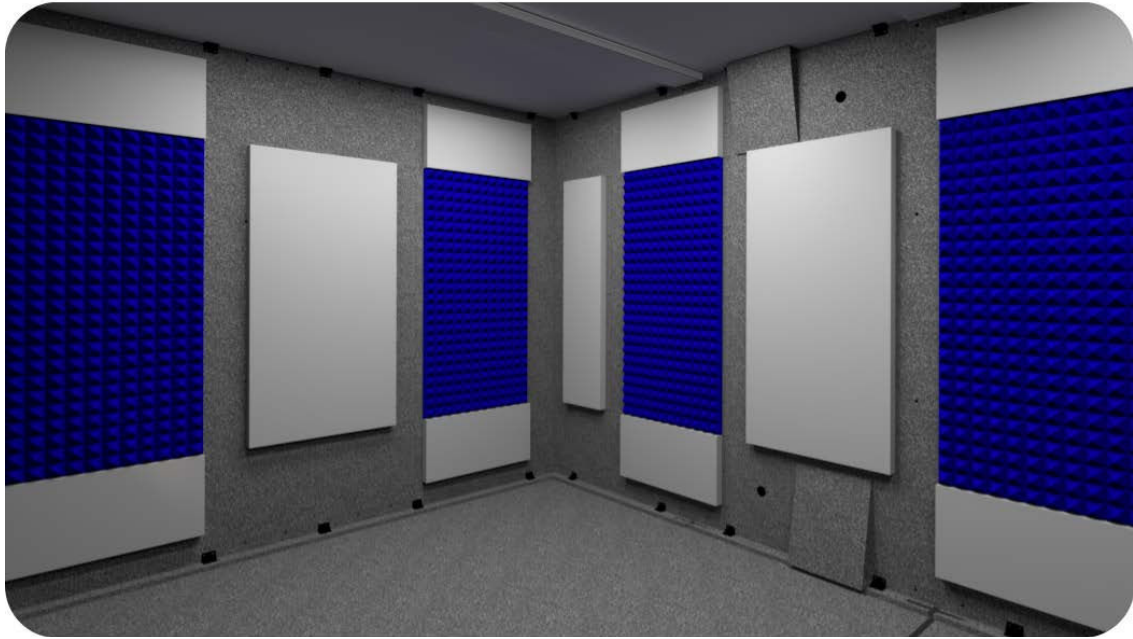

The Acoustic Package offers a versatile and cost-effective solution, allowing every WhisperRoom user to effortlessly craft their desired interior acoustical environment. Its core aim is to elevate sound quality and control within the enclosure. Through sound wave absorption and diffusion, the panels effectively minimize undesired reflections, echo, and reverberation. The outcome is a serene and acoustically refined environment that ensures optimal sound conditions. Each Acoustic Package includes a carefully chosen assortment of the following panel sizes:



- 🌀 1' x 2' Fabric Acoustic Panels
- 🌀 1' x 4' Fabric Acoustic Panels
- 🌀 2' x 4' Fabric Acoustic Panels

**Note: Models vary - some include all three panel sizes, others have two. This ensures tailored acoustics for each WhisperRoom model.**

### Pricing

127 LP	\$331	4230	\$249	4242	\$331
4260	\$331	4284	\$417	4848	\$372
4872	\$496	4896	\$584	6060	\$476
6084	\$585	7272	\$788	7296	\$792
8484	\$711	84102	\$753	84126	\$860
9696	\$668	96120	\$1,002	96144	\$1,025
96168	\$1,130	96192	\$1,279	10284	\$753
102102	\$835	102126	\$984	102144	\$1,066
102168	\$1,152	102186	\$1,238		

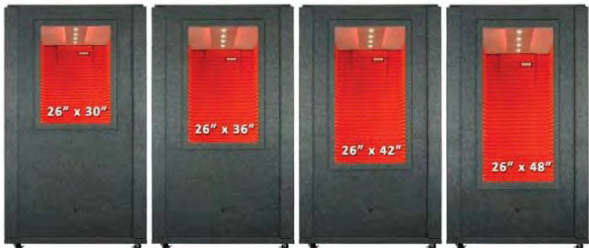
## WDO - Wall Windows

	<b>WDO 2630 S</b> \$500	<b>WDO 2636 S</b> \$590	<b>WDO 2642 S</b> \$685	<b>WDO 2648 S</b> \$775
	<b>WDO 2630 E</b> \$1,055	<b>WDO 2636 E</b> \$1,235	<b>WDO 2642 E</b> \$1,425	<b>WDO 2648 E</b> \$1,605
	<b>WDO 3230 S</b> \$605	<b>WDO 3236 S</b> \$720	<b>WDO 3242 S</b> \$835	<b>WDO 3248 S</b> \$950
	<b>WDO 3230 E</b> \$1,270	<b>WDO 3236 E</b> \$1,500	<b>WDO 3242 E</b> \$1,725	<b>WDO 3248 S</b> \$1,955
<b>30" Windows</b> Provides plenty of visibility applications which require that the user stand inside the WhisperRoom.	<b>36" Windows</b> For applications which require visibility while the user sits, a 36" window is recommended.	<b>42" Windows</b> If an interior desk or table is to be used beneath the window, a 42" window will allow the necessary visibility.	<b>48" Windows</b> The 48" window provides the most visibility.	

Other than size, the design is the same as that of a door window. Each glass unit consists of multiple layers of 1/4" laminated safety glass separated by air buffer(s). Safety glass is used because of its superior noise reduction capabilities, and its safety feature. If broken, it will not shatter. A window DOES NOT reduce the noise reduction capabilities of a WhisperRoom. However, it does increase the amount of interior reflective surface area. An additional cable passage plug is located at the base off each window component.

**\*26-Inch wide windows are only available for 42, 60, 84, 102 Series Models**

**\*32-Inch wide windows are only available for 48, 72, and 96 Series Models**

**NOTE: Must be specific at initial order.**

## MJP - Multi Jack Panel

	<b>Multi Jack Panel</b>  \$795	<b>Additional XLR to 1/4" Adapter</b>  \$30
---	--------------------------------------	---

The Multi Jack Panel is a standalone optional feature that can be installed on your WhisperRoom after it is assembled. It is a pre-wired, jack-panel insert consisting of 2 USB jacks, 4 XLR jacks, and 6 - 1/4" stereo phono jacks. Simply thread the cables through a cable passage to reach the interior box. If your need requires additional 1/4" stereo phono jack, we can add an XLR to 1/4" stereo phono jack adapters for a small charge. This feature is great for audiometric applications.

**NOTE: May be ordered and installed at any time.**



## CP - Caster Plate



The Caster Plate is an additional floor component with wheels to aid in the mobility of a WhisperRoom. The Caster Plate also provides a substantial amount of downward noise control. It adds additional mass in the downward direction and provides a 4" air buffer below the WhisperRoom. This feature is highly recommended for applications where low-end, structurally transmitted noise is a problem. See optional "Step" below.

**NOTE: this option adds 5 inches to the overall height of a unit and may be purchased anytime. However, for ease of assembly, it is recommended to purchase during initial order.**

## Step



An optional exterior Step is now available for situations which require an optional Caster Plate. The step provides a comfortable transition when stepping up, into, and down out of the WhisperRoom. It is highly recommended that the step be used in conjunction with the optional Caster Plate.

**NOTE: Steps are \$195.00 each.**

## HX - 10" Height Extension



WhisperRooms are designed to permit installation in residences and facilities with standard ceiling heights (approximately 8'). However, when additional height is required for equipment or application-specific needs, a 10" height extension upgrade is available

**NOTE: Prior to placing your order you should ensure that the host room's ceiling height will permit the installation of the Height Extension. It must be specified at initial order.**

## IEP Floor - Isolation Enhancement Package Floor



The IEP floor is a 5/16" DURACOUSTIC® mat made of recycled rubber that is included in the Enhanced models or IEP upgrades. It is installed on the floor underneath the WhisperRoom floor and provides additional isolation. The IEP floor can be purchased for standard rooms also and is recommended if there is a possibility of upgrading to an Enhanced (Double-Wall) model at any point in time.

## VSS - Ventilation Silencing System

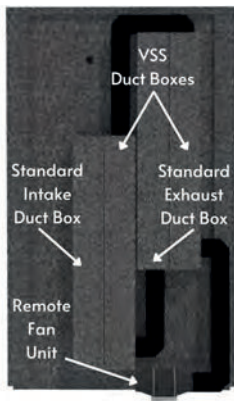

Standard ventilation systems are quiet, but the air-flow noise is still slightly audible inside the WhisperRoom. This noise can be eliminated by the installation of a VSS. The number of VSS units needed depends on the size of the WhisperRoom and the prices listed are for the specific model noted. One VSS is required for each standard ventilation system. Each VSS consists of two additional baffled exhaust ducts with hoses and adapters, linked in-line between the standard exhaust duct and the remote fan unit (RFU).

**NOTE: May be ordered and installed at anytime. Roof-mount ventilation systems and VSS systems available for most models.**

## EFS - Exterior Fan Silencer



WhisperRoom remote fan units have a 38dB noise rating. This slight noise can be eliminated by positioning each fan into an Exterior Fan Silencer (EFS). The number of EFS units needed depends on the size of the WhisperRoom and the number of ventilation systems required.

**NOTE: may be ordered and installed at anytime. \$250.00 each.**

## HEPA Filter



Our HEPA filter is easily installed on any WhisperRoom. Our unique design allows the ventilation to maintain airflow while blocking out unwanted particles into your booth.

HEPA filters are incredibly effective at capturing viruses, bacteria, pollen, mold, and more.

Includes an additional replacement filter. HEPA Filter Dimensions: 10.2" x 6.5" x 1.6".

**NOTE: \$100.00 each.**

## Studio Foam

### Foam Colors

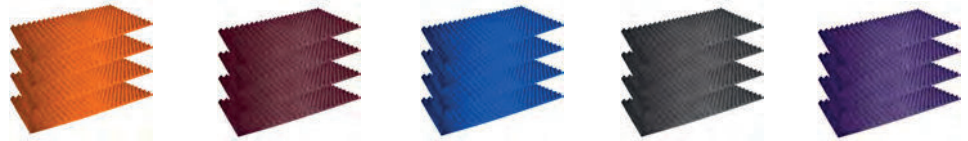

### Foam Type

Foam 2 - \$ 115

Foam 3 - \$ 170

Foam 4 - \$ 225

Purchase additional boxes of foam. Each sheet is 2' x 4' and 2" thick and each box contains the indicated number of sheets. Foam sheets for the ATP (pg. 23) are pre-cut 1' x 2' with Velcro® attached.

## LENRD® Bass Traps



Control low frequencies inside your WhisperRoom™ with LENRD® Bass Traps. These top-of-the-line bass traps are designed to dampen low-frequency sound energy and help you attain a flatter low frequency inside your booth.

**Note: Sold in packs of 2 for \$120.00.**

## Audimute: Fabric Acoustic Panels



Fabric Acoustic Panels make it easy to incorporate acoustics into your décor. Whether it's for home or work, you're sure to find a solution to match your needs with Audimute.

These panels were designed with large scale applications and high-traffic spaces in mind, ideal for schools and commercial spaces. Each panel is custom cut and wrapped in your fabric choice for a tight border without using a metal frame. This straight edge fabric finish makes it easy to butt panels next to each other to build your acoustic design to any size.

- High quality, durable fabric
- Hand assembled in the USA
- Eco-friendly construction
- Excellent acoustic absorption properties - NRC .95
- Fire safe materials - class A fire rated (ASTM E-84)
- Thickness: 1.5"
- Size: 2' x 4'
- Includes Velcro backed Hang Tabs & Screws for mounting

**Note: \$86.00 each**

## Optional Feature Pricing Chart

Model	CP	IEP FLOOR	VSS	AP	EFS	HXS	HXE	SL	IEP
127 LP	\$ 775	\$ 175	\$ 645	\$ 331	\$ 250	\$ 795	\$ 1,440	\$ 325	\$ 4,285
4230	\$ 435	\$ 105	\$ 645	\$ 249	\$ 250	\$ 490	\$ 895	\$ 325	\$ 3,350
4242	\$ 580	\$ 130	\$ 645	\$ 331	\$ 250	\$ 525	\$ 965	\$ 325	\$ 3,400
4260	\$ 715	\$ 155	\$ 645	\$ 331	\$ 250	\$ 720	\$ 1,330	\$ 325	\$ 4,900
4284	\$ 810	\$ 200	\$ 1,290	\$ 417	\$ 500	\$ 785	\$ 1,450	\$ 415	\$ 5,595
4848	\$ 715	\$ 145	\$ 645	\$ 372	\$ 250	\$ 595	\$ 1,070	\$ 325	\$ 4,000
4872	\$ 815	\$ 180	\$ 645	\$ 496	\$ 250	\$ 825	\$ 1,480	\$ 325	\$ 5,200
4896	\$ 930	\$ 225	\$ 1,290	\$ 584	\$ 500	\$ 905	\$ 1,665	\$ 415	\$ 6,375
6060	\$ 1,110	\$ 265	\$ 1,290	\$ 476	\$ 500	\$ 930	\$ 1,715	\$ 325	\$ 6,795
6084	\$ 1,350	\$ 305	\$ 1,290	\$ 585	\$ 500	\$ 995	\$ 1,830	\$ 650	\$ 7,225
7272	\$ 1,375	\$ 315	\$ 1,290	\$ 788	\$ 500	\$ 1,060	\$ 1,905	\$ 415	\$ 7,595
7296	\$ 1,590	\$ 365	\$ 1,290	\$ 792	\$ 500	\$ 1,125	\$ 2,025	\$ 650	\$ 8,285
8484	\$ 1,610	\$ 380	\$ 1,935	\$ 711	\$ 750	\$ 1,055	\$ 1,955	\$ 830	\$ 8,010
84102	\$ 2,185	\$ 530	\$ 1,935	\$ 753	\$ 750	\$ 1,265	\$ 2,350	\$ 830	\$ 9,315
84126	\$ 2,420	\$ 580	\$ 2,580	\$ 860	\$ 1,000	\$ 1,325	\$ 2,460	\$ 1,245	\$ 10,005
9696	\$ 1,860	\$ 440	\$ 1,935	\$ 668	\$ 750	\$ 1,210	\$ 2,250	\$ 830	\$ 9,320
96120	\$ 2,505	\$ 610	\$ 1,935	\$ 1,002	\$ 750	\$ 1,450	\$ 2,700	\$ 830	\$ 11,910
96144	\$ 2,790	\$ 665	\$ 2,580	\$ 1,025	\$ 1,000	\$ 1,525	\$ 2,830	\$ 1,245	\$ 11,735
96168	\$ 3,430	\$ 835	\$ 2,580	\$ 1,130	\$ 1,000	\$ 1,760	\$ 3,275	\$ 1,245	\$ 14,245
96192	\$ 3,720	\$ 890	\$ 2,580	\$ 1,279	\$ 1,000	\$ 1,835	\$ 3,405	\$ 1,660	\$ 14,995
10284	\$ 1,810	\$ 450	\$ 1,935	\$ 753	\$ 750	\$ 1,260	\$ 2,335	\$ 830	\$ 9,470
102102	\$ 2,460	\$ 605	\$ 1,935	\$ 835	\$ 750	\$ 1,465	\$ 2,715	\$ 830	\$ 11,865
102126	\$ 2,710	\$ 675	\$ 2,580	\$ 984	\$ 1,000	\$ 1,525	\$ 2,830	\$ 1,245	\$ 12,950
102144	\$ 3,360	\$ 830	\$ 2,580	\$ 1,066	\$ 1,000	\$ 1,745	\$ 3,220	\$ 1,245	\$ 14,285
102168	\$ 3,620	\$ 900	\$ 2,580	\$ 1,152	\$ 1,000	\$ 1,795	\$ 3,345	\$ 1,660	\$ 14,865
102186	\$ 4,265	\$ 1,055	\$ 2,580	\$ 1,238	\$ 1,000	\$ 2,010	\$ 3,730	\$ 1,660	\$ 17,265

# Assembly Example

